

# GV2P08

TeSys GV2 Manual Starter and Protector, thermal magnetic circuit protector, rotary handle, 2.5 to 4 A, screw clamp

Product availability : Stock - Normally stocked in distribution facility



## Main

Range	TeSys
Product name	TeSys GV2
Device short name	GV2P
Device application	Motor
Trip unit technology	Thermal-magnetic

## Complementary

Poles description	3P
Network type	AC
Utilisation category	AC-3 IEC 60947-4-1 Category A IEC 60947-2
Network frequency	50/60 Hz IEC 60947-4-1
Fixing mode	35 mm symmetrical DIN rail clipped Panel screwed with 2 x M4 screws)
Operating position	Any position
Motor power kW	1.1 kW 400/415 V AC 50/60 Hz 1.5 kW at 500 V AC 50/60 Hz 2.2 kW 690 V AC 50/60 Hz
Breaking capacity	100 kA Icu at 230/240 V AC 50/60 Hz conforming to IEC 60947-2 100 kA Icu 400/415 V AC 50/60 Hz IEC 60947-2 100 kA Icu 440 V AC 50/60 Hz IEC 60947-2 100 kA Icu 500 V AC 50/60 Hz IEC 60947-2 8 kA Icu 690 V AC 50/60 Hz IEC 60947-2
[Ics] rated service short-circuit breaking capacity	100 % 690 V AC 50/60 Hz IEC 60947-2 100 % 500 V AC 50/60 Hz IEC 60947-2 100 % at 230/240 V AC 50/60 Hz conforming to IEC 60947-2 100 % 440 V AC 50/60 Hz IEC 60947-2

\* Price is "List Price" and may be subject to a trade discount – check with your local distributor or retailer for actual price.

100 % 400/415 V AC 50/60 Hz IEC 60947-2

Control type	Rotary knob
Line Rated Current	4 A
Thermal protection adjustment range	2.5...4 A
Magnetic tripping current	51 A
[Ue] rated operational voltage	690 V AC 50/60 Hz IEC 60947-2
[Ui] rated insulation voltage	690 V AC 50/60 Hz IEC 60947-2
[Ith] conventional free air thermal current	4 A IEC 60947-4-1
[Uimp] rated impulse withstand voltage	6 kV IEC 60947-2
Power dissipation per pole	2.5 W
Mechanical durability	100000 cycles
Electrical durability	100000 cycles AC-3 440 V
Maximum operating rate	25 cyc/h
Rated duty	Continuous conforming to IEC 60947-4-1
Connections - terminals	screw clamp terminals 2 0.00...0.01 in <sup>2</sup> (1...6 mm <sup>2</sup> ) solid screw clamp terminals 2 0.00...0.01 in <sup>2</sup> (1.5...6 mm <sup>2</sup> ) flexible without cable end screw clamp terminals 2 0.00...0.01 in <sup>2</sup> (1...4 mm <sup>2</sup> ) flexible with cable end
Tightening torque	15.05 lbf.in (1.7 N.m) screw clamp terminals
Suitability for isolation	Yes conforming to IEC 60947-1
Phase failure sensitivity	Yes IEC 60947-4-1
Height	3.50 in (89 mm)
Width	1.77 in (45 mm)
Depth	3.82 in (97 mm)

## Environment

Standards	EN/IEC 60947-2 EN/IEC 60947-4-1 UL 60947-4-1 CSA C22.2 No 60947-4-1
Product certifications	IECEE CB Scheme UL CSA CCC EAC ATEX BV LROS (Lloyds register of shipping) DNV-GL RINA
Protective treatment	TH
IP degree of protection	IP20 IEC 60529
IK degree of protection	IK04
Ambient air temperature for operation	-4...140 °F (-20...60 °C)
Ambient air temperature for storage	-40...176 °F (-40...80 °C)
Fire resistance	1760 °F (960 °C) IEC 60695-2-1
Operating altitude	2000 m

## Ordering and shipping details

Category	22367 - MANUAL STR PROTECTOR - GV2
Discount Schedule	I11
GTIN	00785901832935
Nbr. of units in pkg.	1
Package weight(Lbs)	0.78 lb(US) (0.35 kg)
Returnability	Yes
Country of origin	TH

## Packing Units

Unit Type of Package 1	PCE
Package 1 Height	1.81 in (4.6 cm)
Package 1 width	3.66 in (9.3 cm)
Package 1 Length	3.94 in (10 cm)
Unit Type of Package 2	S02
Number of Units in Package 2	20
Package 2 Weight	15.01 lb(US) (6.808 kg)
Package 2 Height	5.91 in (15 cm)
Package 2 width	11.81 in (30 cm)
Package 2 Length	15.75 in (40 cm)
Unit Type of Package 3	P06
Number of Units in Package 3	320
Package 3 Weight	264.07 lb(US) (119.78 kg)
Package 3 Height	31.50 in (80 cm)
Package 3 width	31.50 in (80 cm)
Package 3 Length	23.62 in (60 cm)

## Offer Sustainability

Sustainable offer status	Green Premium product
California proposition 65	WARNING: This product can expose you to chemicals including: Antimony oxide & Antimony trioxide, which is known to the State of California to cause cancer. For more information go to <a href="http://www.P65Warnings.ca.gov">www.P65Warnings.ca.gov</a>
REACH Regulation	<a href="#">REACH Declaration</a>
EU RoHS Directive	Compliant <a href="#">EU RoHS Declaration</a>
Mercury free	Yes
RoHS exemption information	<a href="#">Yes</a>
China RoHS Regulation	<a href="#">China RoHS declaration</a> Product out of China RoHS scope. Substance declaration for your information.
Environmental Disclosure	<a href="#">Product Environmental Profile</a>
WEEE	The product must be disposed on European Union markets following specific waste collection and never end up in rubbish bins.

## Contractual warranty

Warranty	18 months
----------	-----------

Thermal-Magnetic Tripping Curves for GV2ME and GV2P

Average Operating Times at 20 °C Related to Multiples of the Setting Current

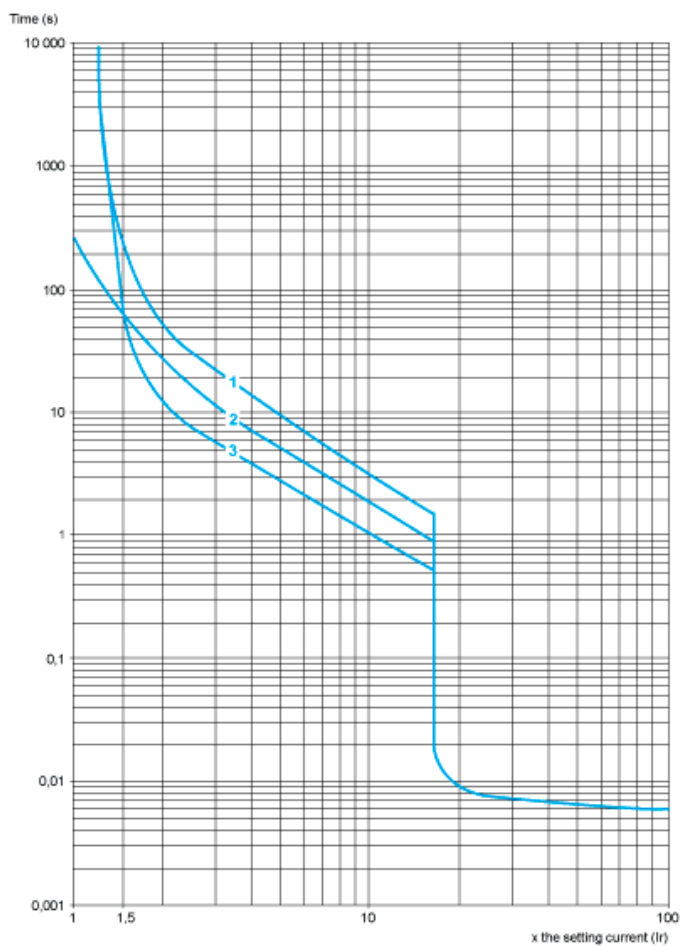

- 1 3 poles from cold state
- 2 2 poles from cold state
- 3 3 poles from hot state

Current Limitation on Short-Circuit for GV2ME and GV2P (3-Phase 400/415 V)

Dynamic Stress

$I_{peak} = f(\text{prospective } I_{sc}) \text{ at } 1.05 U_e = 435 \text{ V}$



- 1 Maximum peak current
- 2 24-32 A
- 3 20-25 A
- 4 17-23 A
- 5 13-18 A
- 6 9-14 A
- 7 6-10 A
- 8 4-6.3 A
- 9 2.5-4 A
- 10 1.6-2.5 A
- 11 1-1.6 A
- 12 Limit of rated ultimate breaking capacity on short-circuit of GV2ME (14, 18, 23, and 25 A ratings).

**Thermal Limit on Short-Circuit for GV2P**

Thermal Limit in  $kA^2s$  in the Magnetic Operating Zone

Sum of  $I^2dt = f$  (prospective Isc) at 1.05 Ue = 435 V

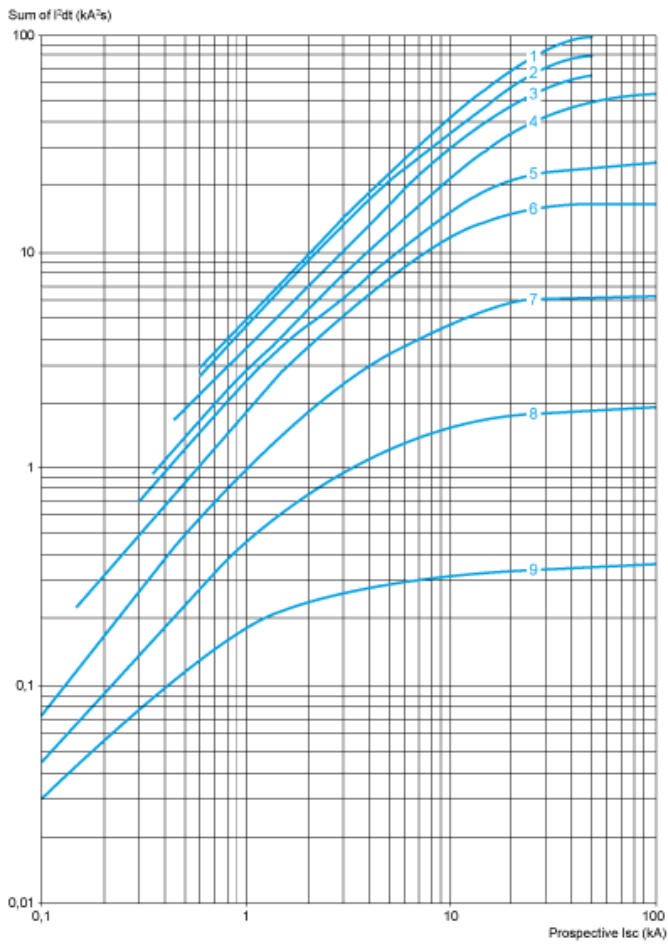

- |    |           |
|----|-----------|
| 1  | 24-32 A   |
| 2  | 20-25 A   |
| 3  | 17-23 A   |
| 4  | 13-18 A   |
| 5  | 9-14 A    |
| 6  | 6-10 A    |
| 7  | 4-6.3 A   |
| 8  | 2.5-4 A   |
| 9  | 1.6-2.5 A |
| 10 | 1-1.6 A   |

GV2P

On rail AM1 DE200, ED200 (35 x 15)

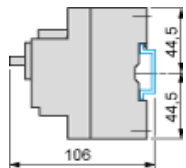

Panel mounted

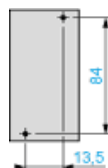

On pre-slotted plate AM1 PA

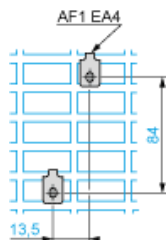

Adapter plate GK2AF01

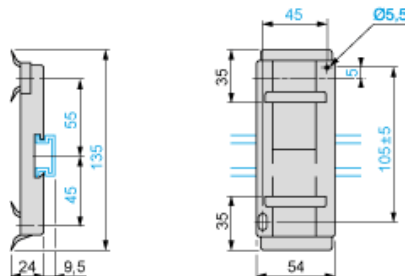

Combination GV2P + TeSys d contactor

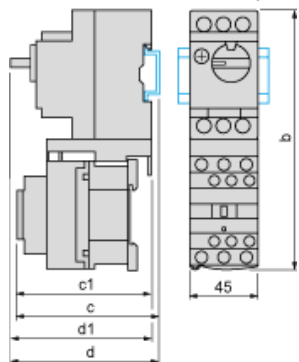

GV2P +	LC1D09...D18	LC1D25 and D32
b	176.4	186.8
c1	100.1	106.4

GV2P +	LC1D09...D18	LC1D25 and D32
c	105.6	111.9
d1	95	95
d	100.5	100.5

## Mounting

Mounting of External Operator GV2APN01, GV2APN02 or GV2APN04 for Motor Circuit Breakers GV2P

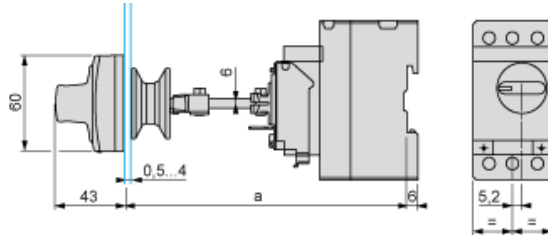

Door cut-out

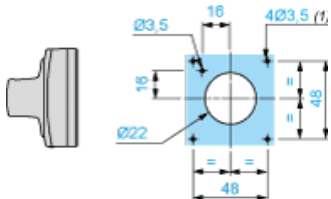

(1) For IP65 only.

Mounting of External Operator GVAPH02 for Motor Circuit Breakers GV2P

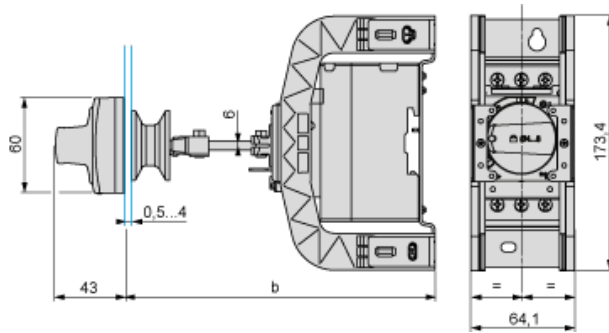

	a		b	
	Minimum	Maximum	Minimum	Maximum
GV2APN..	140	250	–	–
GV2APN.. + GVAPH02	–	–	151	250
GV2APN.. + GVAPK11	250	434	–	–
GV2APN.. + GVAPH02 + GVAPK11	–	–	250	445

Door cut-out

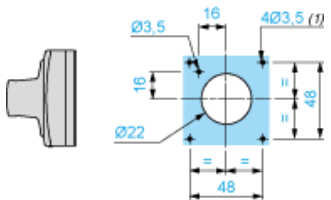

(1) For IP65 only.

GV2P••

